

ARLU[®]
DIVINA

DIVINA[®]

Architectural glass partitions and doors
to optimize your space

Divina - architectural glass partitions and doors to optimize your space. With a large number of possible configurations, the Divina range fits into any interior. The innovative aluminium structure provides a refined and minimalist look that is perfect for homes, offices, hotels, and restaurants.

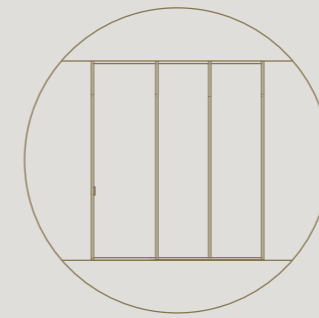

Floor-to-ceiling application possible

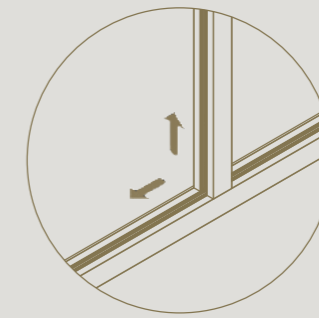

2D adjustable for a perfect alignment with floor and ceiling

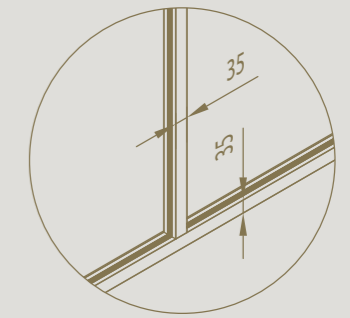

35 mm wide profiles suitable for different glass thicknesses

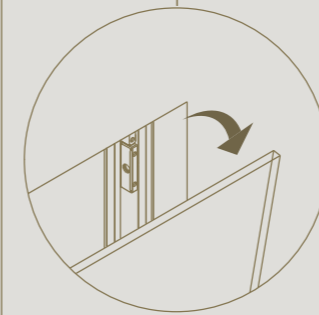

Glass can easily be replaced without causing damage.

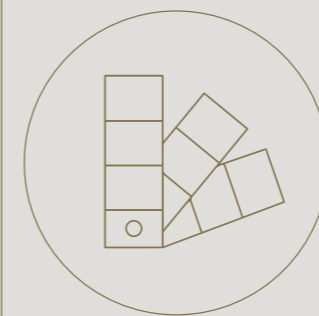

Available in different colours

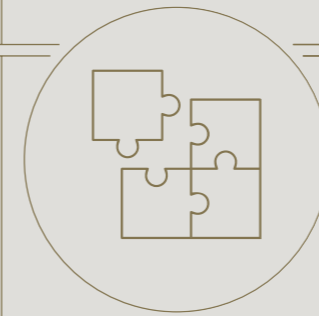

Modular system thanks to unique profiles

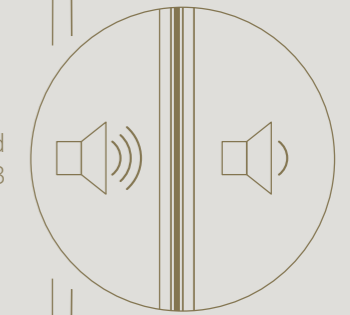

Reduces sound up to 33 dB

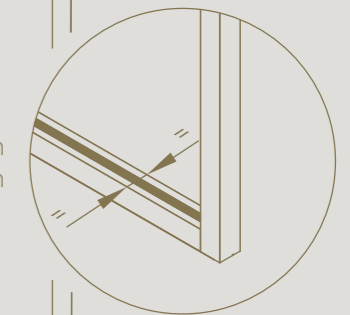

Both sides have an identical finish

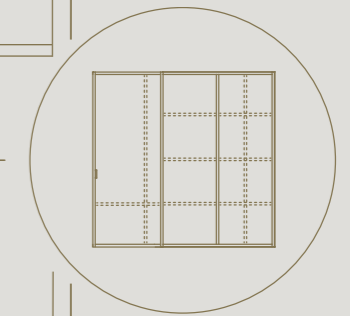

Optional decorative profiles can be positioned as desired

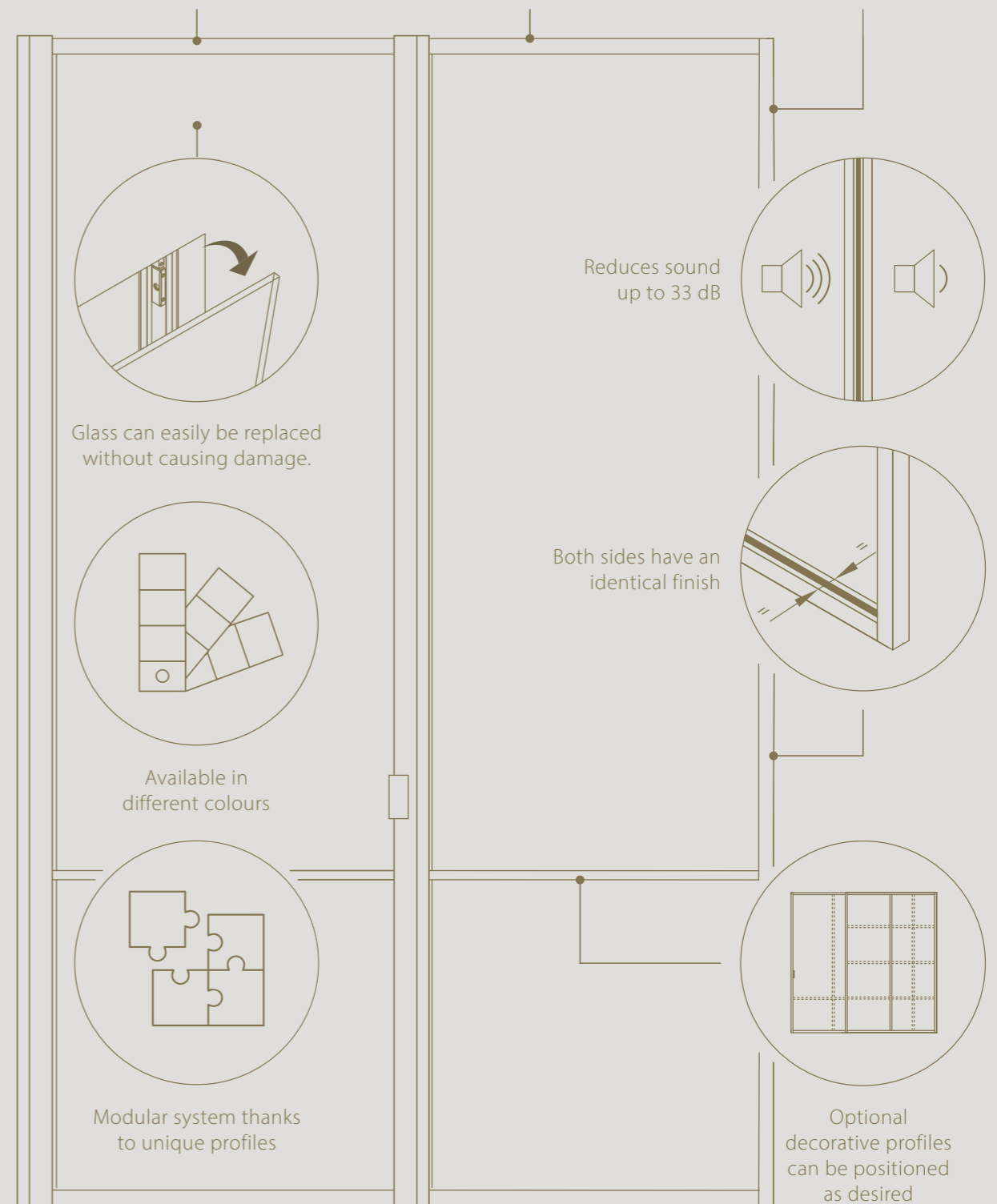



CONFIGURATIONS



DIVINA

FIXED WALL

Thanks to the Divina glass partitions, rooms can easily be divided without sacrificing light and openness.

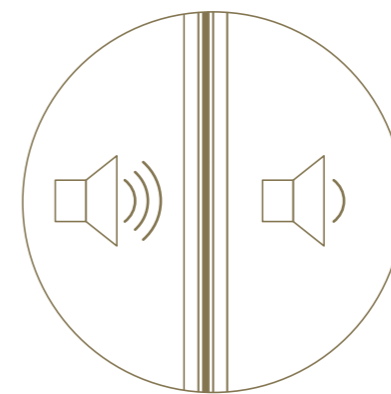

Divina glass walls dampen sound
up to 33 dB
(ISO 717-1)

DIVINA

FIXED WALL WITH END POST

End posts give a sleek finish to Divina fixed walls.

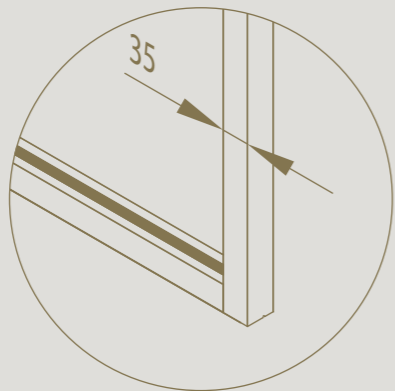

Refined 35 mm side profile,
in line with other profiles





DIVINA



CORNER

The corner profile offers the possibility to connect walls and build complete rooms with Divina.

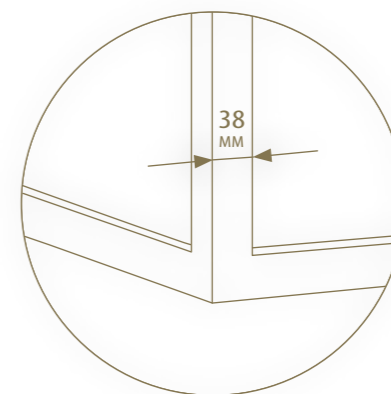

No visible differences between the thin corner profile and standard profiles

PLAY WITH SHAPES

CREATE DIFFERENT STYLES USING **STRAIGHT** OR **CURVED** DECORATIVE PROFILES.

The straight and curved Divina profiles bring refined elegance to your glass walls, elevating any interior to the next level. With their sleek, minimalist design, they blend effortlessly into both modern and classic spaces, subtly enhancing the overall architecture.

There are endless design options available within the curved profiles. From gently undulating to distinctly geometric, each design offers a visual added value.

More info:



DIVINA

SWING DOOR

A minimalist eye-catcher in any interior.

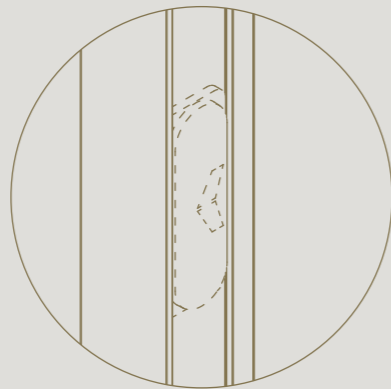

Magnetica® magnetic closure
invisibly integrated

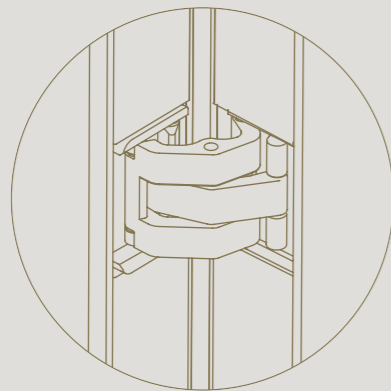

Seamless integration of
Invisible Tyo® hinges

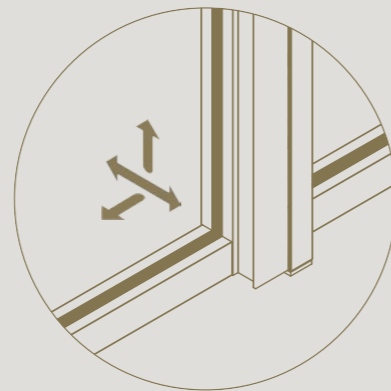

3D adjustable thanks to the height,
width and depth adjustment





DIVINA

DOUBLE SWING DOOR

A passively locked door and an active door form a minimalist solution for practical double swing doors.

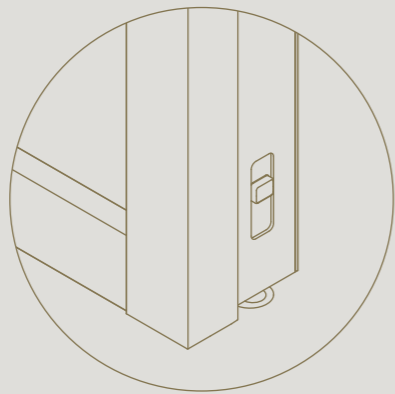

Discreet slider to simultaneously release the upper and lower lock of the passive door

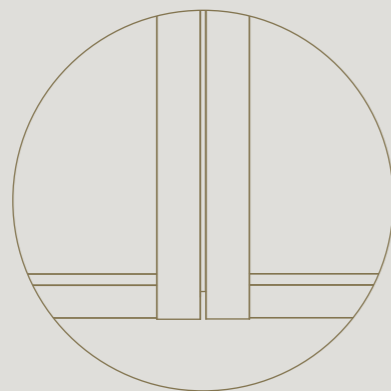

Active and passive door with equally slim profiles

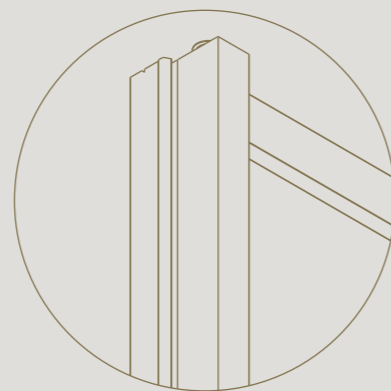

Equipped with a slam post between both doors





DIVINA

FIXED WALL WITH SWING DOOR

Thanks to Divina fixed wall with swing door, you can close off spaces without sacrificing the visual connection between different rooms.

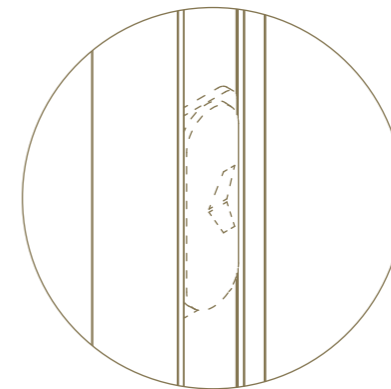

Magnotica® magnetic closure
invisibly integrated

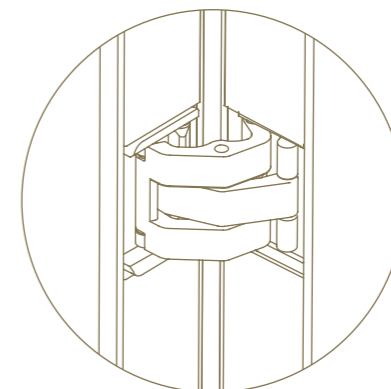

Seamless integration of
Invisible Tyo® hinges





DIVINA



SLIDING DOOR

A sliding door in line with its fixed wall.

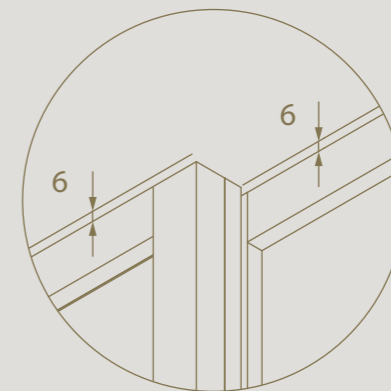

The recessed running track ensures all profiles are seamlessly aligned

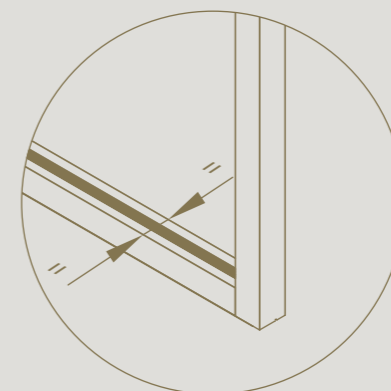

Identical finish on both sides of the sliding door

DIVINA

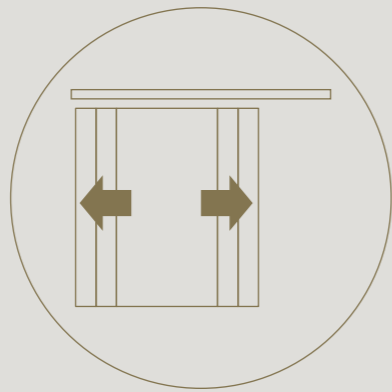

Sliding doors feature a double-acting soft close

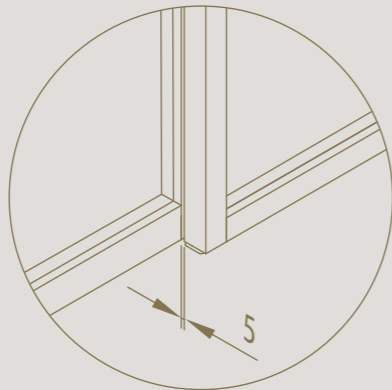

The distance between wall and door can be adjusted to a minimum of 5 mm





DIVINA

PIVOTING DOOR

Pivot solutions for Divina doors.

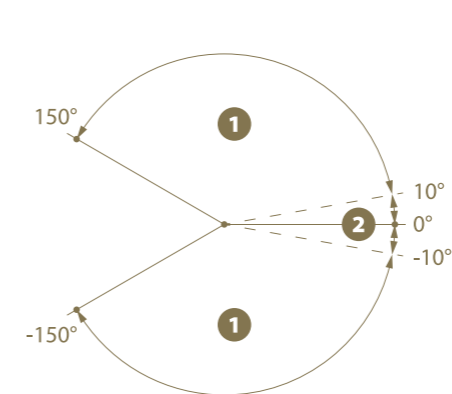
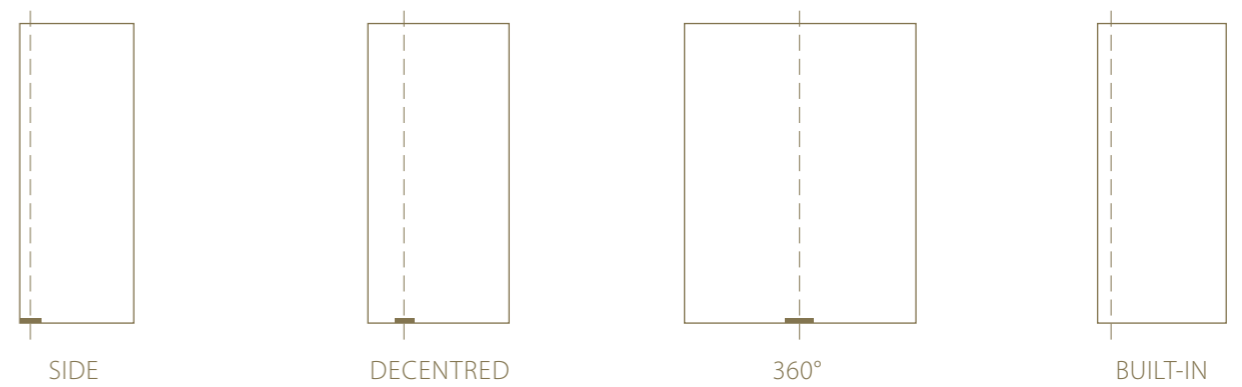

Always equipped with adjustable closing speed **1** and damping **2**

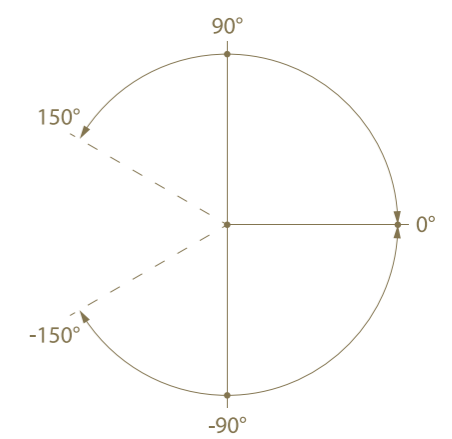

All models hold at 0° and 90°, except the 360° model, which also holds at 180°, 270° and 360°.

ADD COLOUR TO YOUR SPACE

Divina comes in a wide range
of colours and can be fully
tailored to add a personal
touch to any space.*

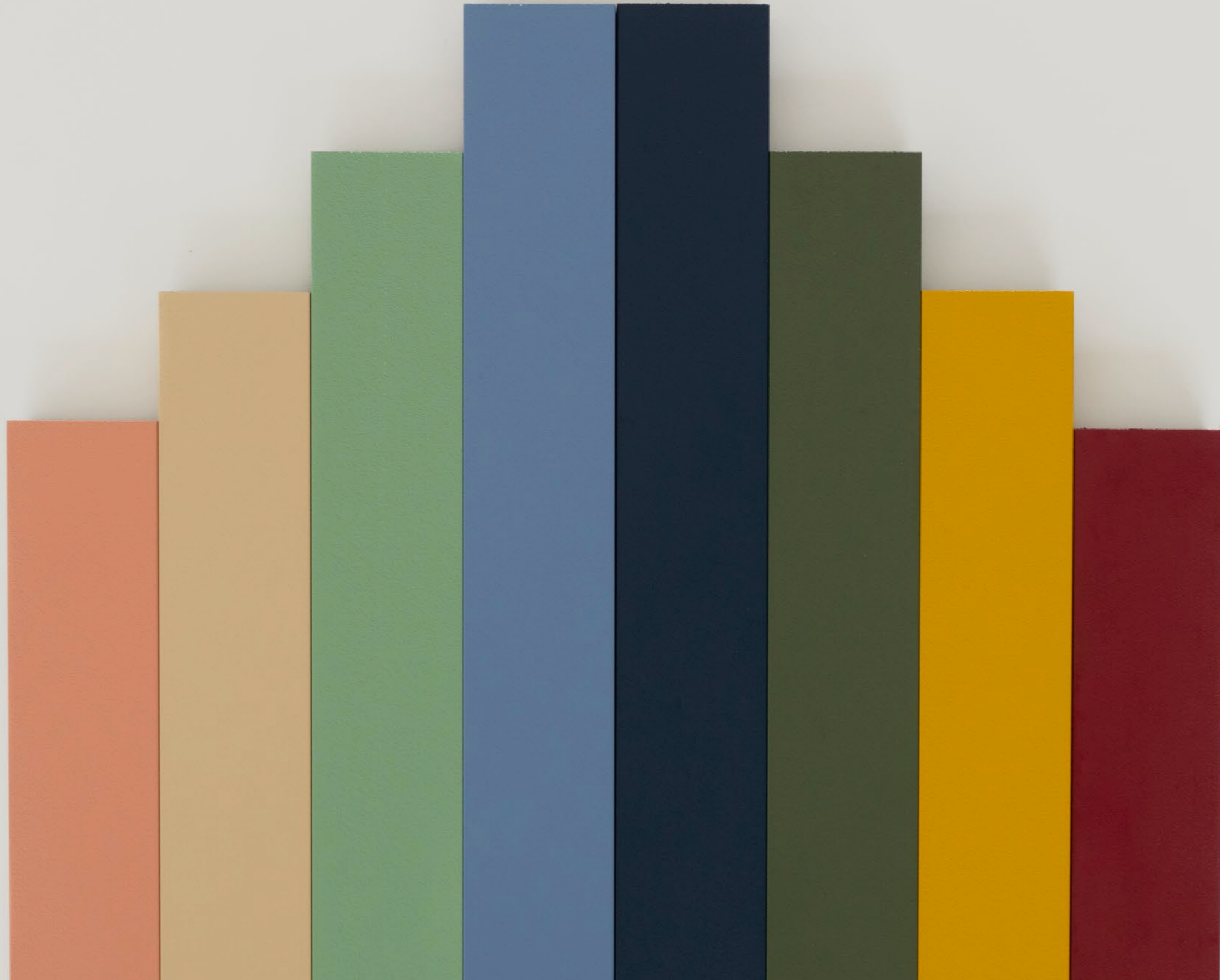

*BESPOKE PROJECTS:
CONTACT US FOR MORE
INFORMATION AT
INFO@ARLU.BE



—●— TXT6021

COLOURS

STANDARD COLOURS



WHITE TXT9016



GREY TXT7016

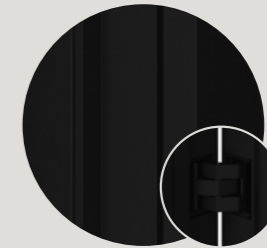

BLACK TXT9005

COLOURS ON DEMAND

POWDER COATING

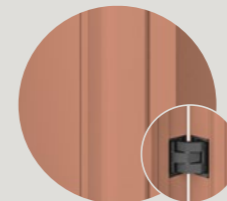

ROSA TXT3012



DUNA TXT1001

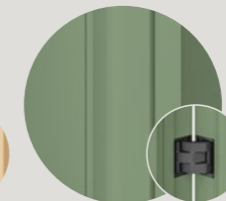

FRESCA TXT6021

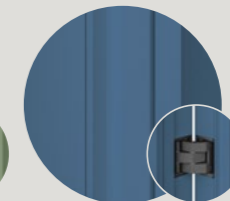

PALOMA TXT5014

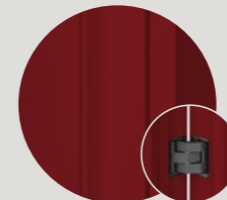

GRANATA TXT3004

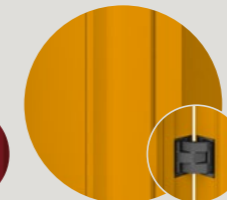

AMBRA TXT1005

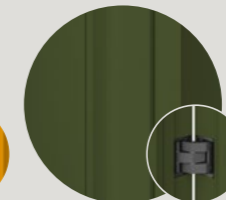

OLIVA TXT6003

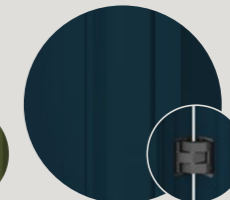

OSCURA TXT5011

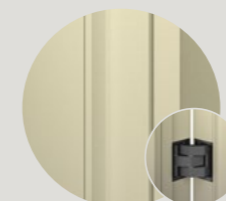

LUMA TXT

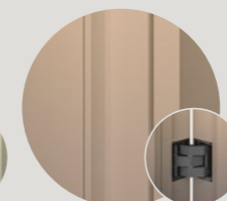

BRONZA TXT

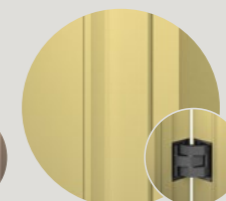

SABBIA TXT

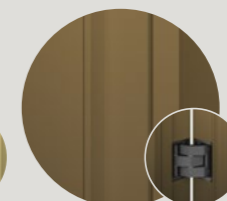

MOCHA TXT

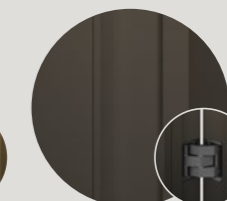

QAWA TXT

ANODIZED

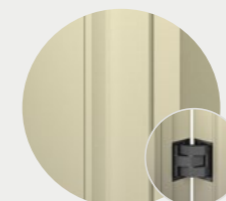

LUMA

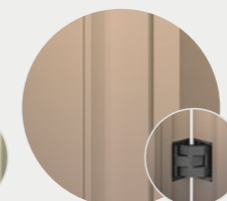

BRONZA

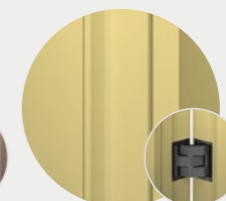

SABBIA

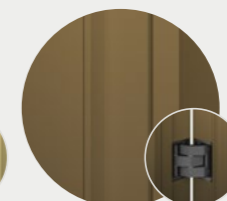

MOCHA

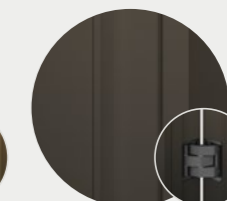

QAWA

Actual colours may vary.

ACCESSORIES

STYLISH DOOR HANDLE

SWING DOOR



PIVOTING DOOR



SLIDING DOOR



AVAILABLE IN ALL COLOURS

CYLINDER LOCK



OPTIONAL CYLINDER LOCK FOR
DIVINA HINGED DOORS

MORE INFO





argenta

* L 2 0 0 1 4 1 7 0 1 *
©2001/417/01 09/25 English



ARLU®

OPENING DOORS



ARLU.BE